



LKEC

Eccentrico  $\varnothing 15$  • Eccentric  $\varnothing 15$



	$\varnothing$	L	i	<input type="checkbox"/>		$\varnothing$	L	i	<input type="checkbox"/>
LKEC16	15	10	6	12	LKEC03	15	13,8	9/9,5	18/20
LKEC01	15	12	7,5	15	LKEC04	15	17	12,5	25
LKEC02	15	12,5	8	16	LKEC18	15	19	14,5	28/30

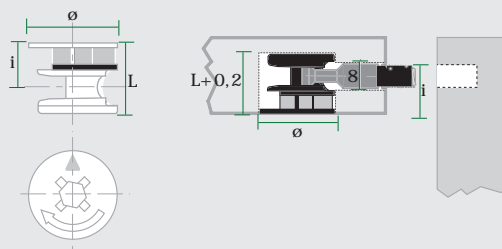

materiale • material

Zama • Zamec

finitura • finish

ZL - ZZ - ZZT - ZZN - ZNL - ZBR - ZO

LKCF04

Coprieccentrico • Covercap



	$\varnothing$	$\varnothing 1$
LKCF04	17	4

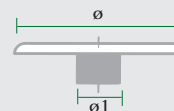

materiale • material

Plastica • Plastic

finitura • finish

PB - PNE - PMA - PFR - PCI - PAC

LKEC

Eccentrico  $\varnothing 15$  con bordo • Eccentric  $\varnothing 15$  with cover rim



	$\varnothing$	L	i	$\varnothing 1$	<input type="checkbox"/>
LKEC05	15	13,8	9/9,5	16,5	18/20
LKEC06	15	17	12,5	16,5	25
LKEC19	15	19	14,5	16,5	28/30

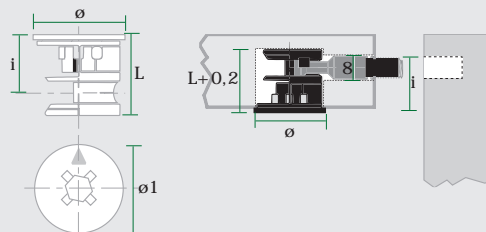

materiale • material

Zama • Zamec

finitura • finish

ZL - ZZ - ZZT - ZZN - ZNL - ZBR - ZO

LKTE

Tirante per eccentrico  $\varnothing 15$  • Dowel for eccentric  $\varnothing 15$



	$\varnothing$	i	M	L
LKTE01	7	34	6 euro	11
LKTE33	7	34	6 euro	7,5
LKTE17	7	34	6 euro	15
LKTE06	7	24	4 euro	12,5

	$\varnothing$	i	M	L
LKTE02	7	24	6 euro	11
LKTE28	7	28	6 euro	11
LKTE05	7	34	4 euro	12,5

materiale • material

Ferro • Steel

finitura • finish

FZ

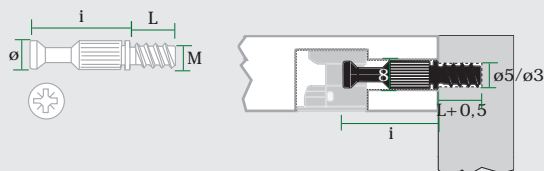

LKTE

Tirante per eccentrico  $\varnothing 15$  • Dowel for eccentric  $\varnothing 15$



	$\varnothing$	i	M	L
LKTE03	7	34	M6	8
LKTE04	7	24	M6	8
LKTE07	7	34	M4	8

	$\varnothing$	i	M	L
LKTE08	7	24	M4	8
LKTE16	7	28	M6	8

materiale • material

Ferro • Steel

finitura • finish

FZ

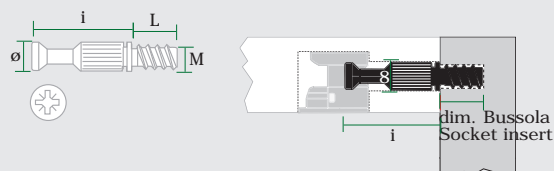

LKTE

Tirante rullato • Rolled dowel



	$\varnothing$	i	M	L
LKTE15	7	34	6 euro	11
LKTE26	7	24	6 euro	11
LKTE31	7	34	4 euro	8,6

materiale • material

Ferro • Steel

finitura • finish

FZ

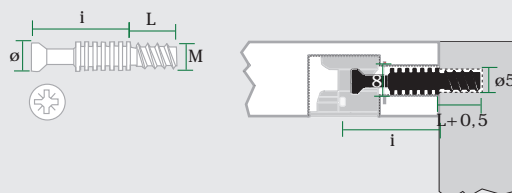



LKTE20

Tirante rullato M6 • Rolled dowel M6



materiale • material

Ferro • Steel

finitura • finish

FZ

LKTE20

ø	i	M	L
7	34	M6	8,5

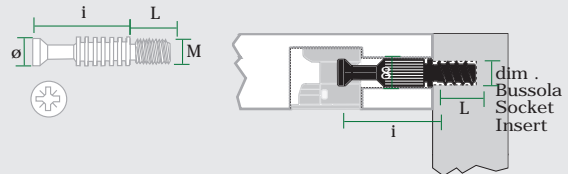

LKTE13

Tirante doppio ad angolo • Angle double dowel



materiale • material

Ferro • Steel

finitura • finish

FZ

LKTE13

ø	i
7	44

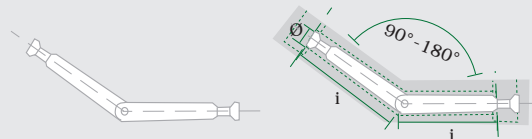

LKTE14

Tirante ad angolo M6 • Angle Dowel M6



materiale • material

Ferro • Steel

finitura • finish

FZ

LKTE14

ø	M	i
7	M6	44

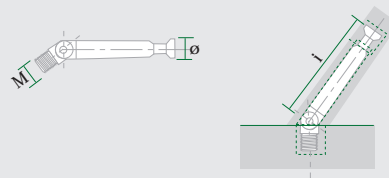

LKEC12

Eccentrico  $\varnothing 25$  • Eccentric  $\varnothing 25$



materiale • material

Zama • Zamec

finitura • finish

ZL

	$\varnothing$	L	i
LKEC12	25	11,5	7

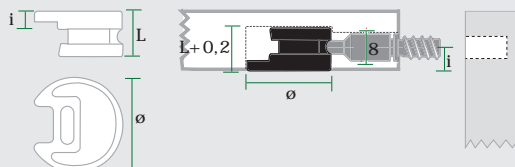

LKTE28

Tirante per eccentrico  $\varnothing 25$  • Dowel for eccentric  $\varnothing 25$



materiale • material

Ferro • Steel

finitura • finish

FZ

	$\varnothing$	i	M	L	F
LKTE28	7	28	6EURO	11	33,50

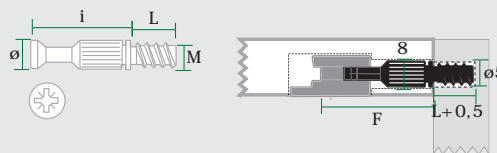

LKTE16

Tirante per eccentrico  $\varnothing 25$  • Dowel for eccentric  $\varnothing 25$



materiale • material

Ferro • Steel

finitura • finish

FZ

	$\varnothing$	i	M	L	F
LKTE16	7	28	M6	8	33,50

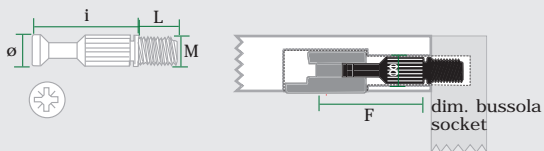



LKCF08

Coprieccentrico • Covercap



materiale • material

Plastica • Plastic

finitura • finish

PB - PNE - PMA

	ø	H
LKCF08	30	1,5

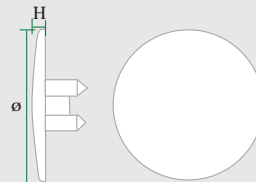

LKBO

Barilotto ø14 con bordo • Housing ø14 with cover rim.



materiale • material

Zama • Zamec

finitura • finish

ZZ - ZZT - ZZN - ZBR

	ø	L	M	i			ø	L	M	i	
LKB007	14	13	M8	8	16	LKB030	14	17,5	M8	12,5	25
LKB001	14	14	M8	9	18	LKB014	14	13	8x1	8	16
LKB008	14	15	M8	10	20	LKB015	14	14	8x1	9	18
LKB024	14	16	M8	11	22	LKB016	14	15	8x1	10	20

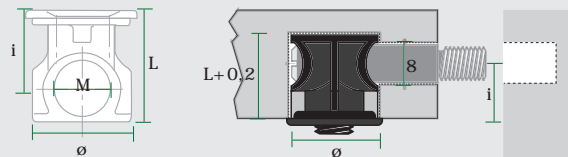

LKBO

Barilotto ø14 senza bordo • Housing ø14 without cover rim.



materiale • material

Zama • Zamec

finitura • finish

ZZ - ZZT - ZZN - ZBR

	ø	L	M	i			ø	L	M	i	
LKB009	14	13	M8	8	16	LKB031	14	17,5	M8	12,5	25
LKB010	14	14	M8	9	18	LKB017	14	13	8x1	8	16
LKB011	14	15	M8	10	20	LKB018	14	14	8x1	9	18
LKB027	14	16	M8	11	22	LKB019	14	15	8x1	10	20

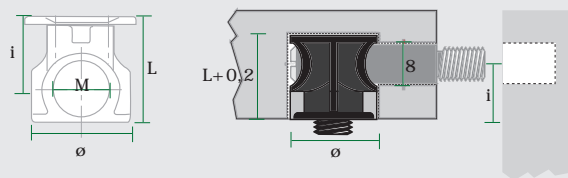

LKGR

Grano M8 • Conic Screw M8



materiale • material

Ferro • Steel - Zama • Zamec

finitura • finish

FZ - FZT - FZN - FBR  
ZL - ZZ - ZZT - ZZN - ZBR

	M	L	Mater		M	L	Mater
LKGR09	M8	8	Zama/Zamec	LKGR17	M8	12,5	Ferro/Steel
LKGR01	M8	10	Zama/Zamec	LKGR12	8x1	10	Zama/Zamec
LKGR02	M8	10	Ferro/Steel	LKGR15	8x1	12	Zama/Zamec
LKGR08	M8	12	Zama/Zamec				

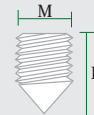

LKTF

Tirante  $\varnothing 7$  • Dowel  $\varnothing 7$



materiale • material

Ferro • Steel

finitura • finish

FZ

	$\varnothing$	L	M	i	F		$\varnothing$	L	M	i	F
LKTF01	7	33,5	M6	18,5	20	LKTF11	8	36	M8	20	21,5
LKTF02	7	35	M6	20	21,5	LKTF12	7	37	6euro	20	21,5
LKTF03	7	43,5	M6	28,5	30	LKTF16	7	45	6euro	27	28,5
LKTF04	7	45	M6	30	31,5						

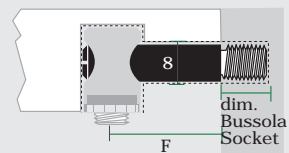
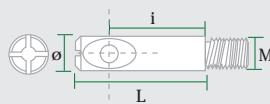

LKBO

Barilotto  $\varnothing 15$  senza bordo • Housing  $\varnothing 15$  without cover rim



materiale • material

Zama • Zamec

finitura • finish

ZZ - ZZT - ZZN - ZBR

	$\varnothing$	L	M	i			$\varnothing$	L	M	i	
LKB032	15	13	M8	8	16	LKB044	15	14	8x1	9	18
LKB034	15	14	M8	9	18	LKB043	15	15	8x1	10	20
LKB033	15	15	M8	10	20						

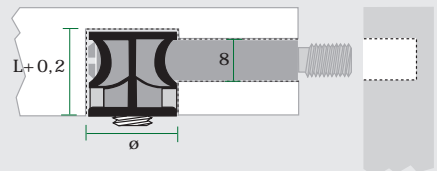
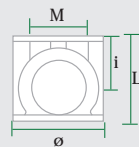



LKBO

Barilotto ø16 con bordo • Housing ø16 with cover rim



	ø	L	M	i	
LKB002	16	18	M10	11	22
LKB003	16	19,5	M10	12,5	25
LKB021	16	22	M10	15	30

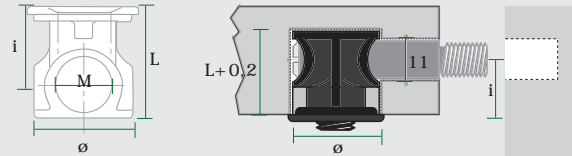

materiale • material

Zama • Zamec

finitura • finish

ZL-ZZ-ZZT-ZZN-ZBR

LKBO

Barilotto ø16 senza bordo • Housing ø16 without cover rim



	ø	L	M	i	
LKB012	16	18	M10	11	22
LKB013	16	19,5	M10	12,5	25
LKB022	16	22	M10	15	30

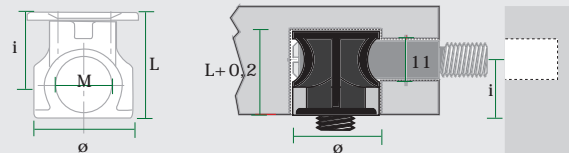

materiale • material

Zama • Zamec

finitura • finish

ZZ - ZZT - ZZN - ZBR

LKGR

Grano M10 • Conic screw M10



	M	L	Mater		M	L	Mater
LKGR05	M10	12,5	Zama/Zamec	LKGR19	M10	16	Ferro/Steel
LKGR11	M10	13,5	Zama/Zamec	LKGR04	M10	10	Ferro/Steel
LKGR13	M10	16	Zama/Zamec				

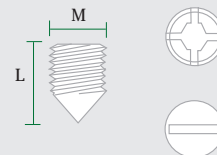

materiale • material

Zama • Zamec - Ferro • Steel

finitura • finish

ZL - ZZ - ZZT - ZZN - ZBR  
FZ - FZT - FZN - FBR

LKTF

Tirante  $\varnothing 10$  • Dowel  $\varnothing 10$



	$\varnothing$	L	M	i	F		$\varnothing$	L	M	i	F
LKTF05	10	36	M6	20	21,5	LKTF07	10	46	M6	30	31,5
LKTF06	10	36	M8	20	21,5	LKTF08	10	46	M8	30	31,5
LKTF14	10	36	7/16	20	21,5						

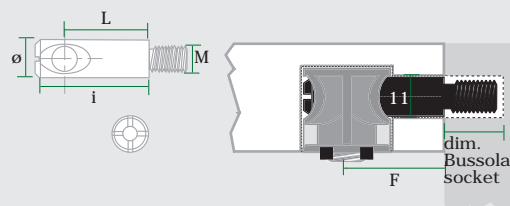

materiale • material

Ferro • Steel

finitura • finish

FZ

LKTFD10

Tirante doppio • Double dowel



	$\varnothing$	L	i
LKTFD10	10	80	60

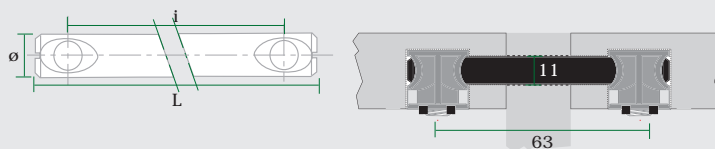

materiale • material

Ferro • Steel

finitura • finish

FZ

LKCF

Copriforo  $\varnothing 14-16$  • Covercap  $\varnothing 14-16$



	$\varnothing$	H	D
LKCF06	14	3	16
LKCF07	16	3	18

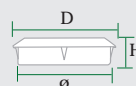

materiale • material

Plastica • Plastic

finitura • finish

PB - PNE - PMA





LKTF80

Tirante trio ø7 • Trio dowel ø7



materiale • material

Ferro • Steel

finitura • finish

FZ

	ø	L	M	i	F
LKTF80	7	35	M6	20	21,5

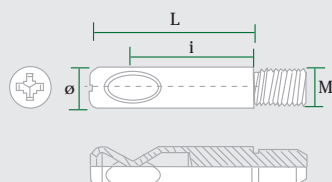

LKBO80

Barilotto Trio ø14 • Housing screw ø8



materiale • material

Zama • Zamec

finitura • finish

FZ

	ø	L	M	i	F
LKBO80	14	14	M8	9	18

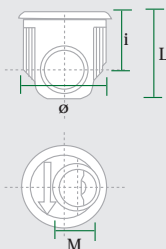

LKGR80

Grano Trio M8 • Trio conic screw



materiale • material

Ferro • Steel

finitura • finish

FZ

	M	L
LKGR80	M8	9

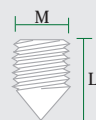

LKCF

Copriforo • Covercap



materiale • material

Plastica • Plastic

finitura • finish

PB - PNE - PMA - PFR - PCI - PAC

	ø	ø1
LKCF04	17	4

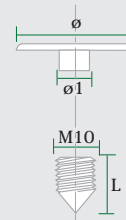

LKBU

Bussola zama con esagono • Die cast socket w/hex inside



materiale • material

Zama • Zamec

finitura • finish

ZL - ZZ

	ø	ø1	L	M		ø	ø1	L	M
LKBU36	8	9,5	10	M6	LKBU29	10	12	20	M8
LKBU01	8	9,5	13	M6	LKBU37	10	12	22	M8
LKBU02	8	9,5	15	M6	LKBU38	10	12	24	M8
LKBU03	8	9,5	17	M6	LKBU32	10	12	15	7/6
LKBU04	8	9,5	20	M6	LKBU06	12	15	18	M10
LKBU05	10	12	15	M8					

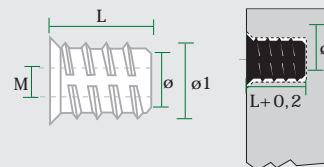

LKBU

Bussola ottone esagonale M6 con sfera • Brass hex socket M6 w/ball.



materiale • material

Ottone • Ottone

finitura • finish

OL

	CH	L	M
LKBU12	8	12	M6
LKBU13	8	9	M6
LKBU39	8	9	M6

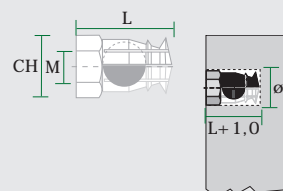



LKBU

Bussola ottone esagonale M6 senza sfera • Brass hex socket w/out ball



	CH	L	M
LKBU54	8	12	M6
LKBU55	8	9	M6

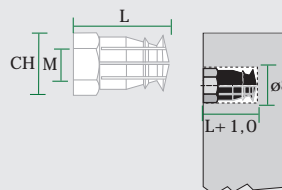

materiale • material

Ottone • Brass

finitura • finish

OL

LKBU

Bussola ottone cilindrica • Round brass socket



	ø	L	M
LKBU07	5,2	8	M4
LKBU08	5,2	10	M4
LKBU60	6,3	8	M4

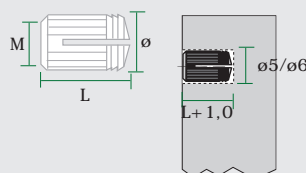

materiale • material

Ferro • Steel

finitura • finish

FZ

LKBU

Bussola ottone esagonale M4 • Brass hex socket M4



	CH	L	M
LKBU24	5,5	10	M4
LKBU33	5,5	7,5	M4

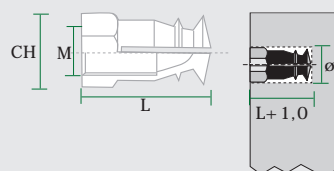

materiale • material

Ottone • Brass

finitura • finish

OL

LKTIO6

Tirante in zama fissaggio diretto • Dowel direct fixing thread



materiale • material

Zama • Zamtec

finitura • finish

ZL - ZZ

	ø	M	L
LKTIO6	5	8EURO	11

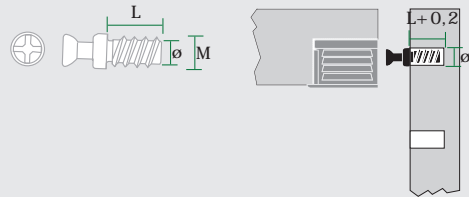

LKTI

Tirante in ferro fissaggio diretto • Dowel direct fixing thread



materiale • material

Ferro • Steel

finitura • finish

FZ

	ø	M	L
LKTI01	5	8EURO	12
LKTI02	5	8EURO	7,5
LKTI03	3	3,8EURO	11

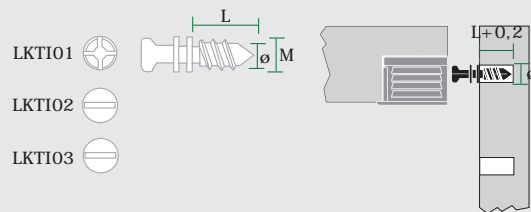

LKTI

Tirante in ferro filetto metrico • Dowel w/M4 - M6 thread



materiale • material

Ferro • Steel

finitura • finish

FZ

	M	L
LKTIO4	M6	8
LKTIO5	M4	8

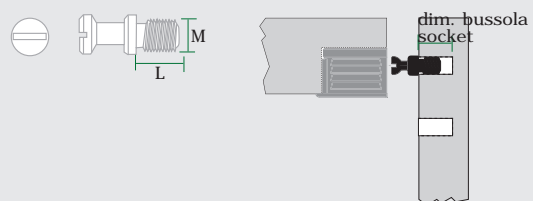



LKSE

Montaggio Verticale  $\varnothing 25$  • Shelf application from top  $\varnothing 25$



materiale • material

Plastica + Zama • Plastic + Zamac

finitura • finish

PB - PNE - PMA

	$\varnothing$	L	
LKSE10	25	14	18
LKSE11	25	16	22
LKSE12	25	17	25

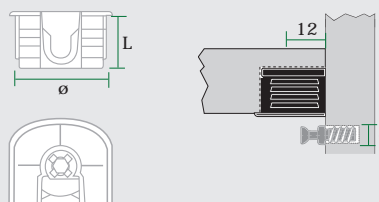

LKTI

Tirante montaggio  $\varnothing 25$  • Dowel for shelf application  $\varnothing 25$



materiale • material

Ferro • Steel

finitura • finish

FZ

	$\varnothing$	M	L
LKTI11	5	6euro	9
LKTI12	-	M6	9

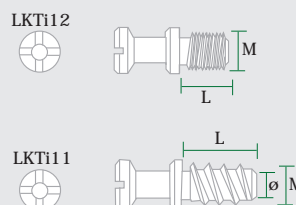

LKSI

Supporto  $\varnothing 20$  • Support  $\varnothing 20$



materiale • material

Plastica • Plastic

finitura • finish

PB - PNE - PMA

	$\varnothing$	L	i	
LKSI03	20	12,5	8	16
LKSI04	20	14	9,5	18/20

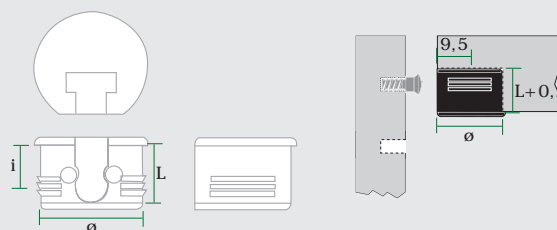

LKBU

Bussola ottone esagonale M4 c/esfera • Brass hex socket M4 w/ball



	CH	L	M
LKBU57	5,5	10	M4

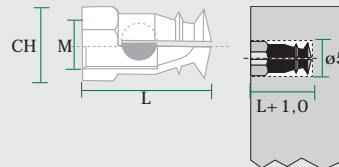

materiale • material

Ottone • Brass

finitura • finish

OL

LKSE

Montaggio verticale • Shelf application from the top



	ø	L	▶
LKSE04	20	12,5	16
LKSE05	20	14	18/20
LKSE06	20	17,5	25

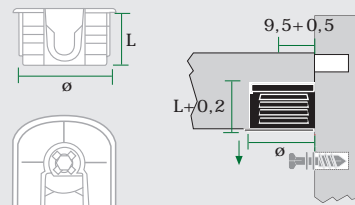

materiale • material

Zama • Zamec

finitura • finish

PB - PNE - PMA

LKSE

Montaggio verticale/orizzontale • Shelf application from the top or laterally



	ø	L	▶
LKSE01	20	12,5	16
LKSE02	20	14	18/20
LKSE03	20	17,5	25

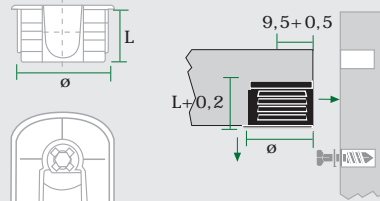

materiale • material

Plastica + Zama • Plastic + Zinc Alloy

finitura • finish

PB - PNE - PMA



LKVE

Vite fissaggio • Connecting screw



materiale • material

Ferro • Steel

finitura • finish

FZ

	M	L
LKVE08	8euro	9,5
LKVE07	4euro	11

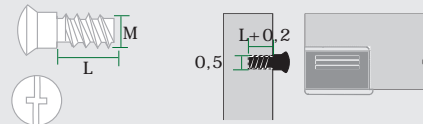

LKSI02

Supporto ø19 • Support ø19



materiale • material

Plastica • Plastic

finitura • finish

PNE - PB- PMA

	ø	L	L1	ø1
LKSI02	19	7	25	9

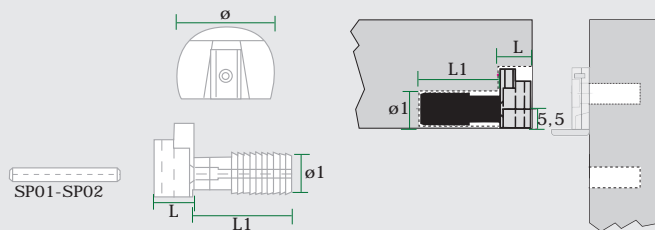

LKSI05

Supporto ø19 expanding • Support ø19 expanding



materiale • material

Plastica • Plastic

finitura • finish

PNE

	ø	L	L1	ø1
LKSI05	19	7	25	9

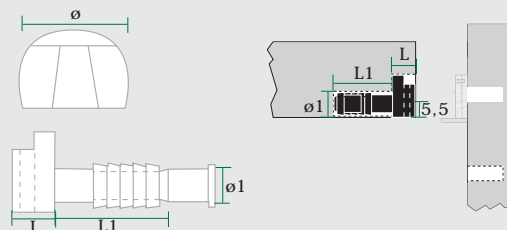

LKST

Staffa standard • Standard support



materiale • material

Zama • Zamec

finitura • finish

ZNL - ZBR - ZZN - ZZ

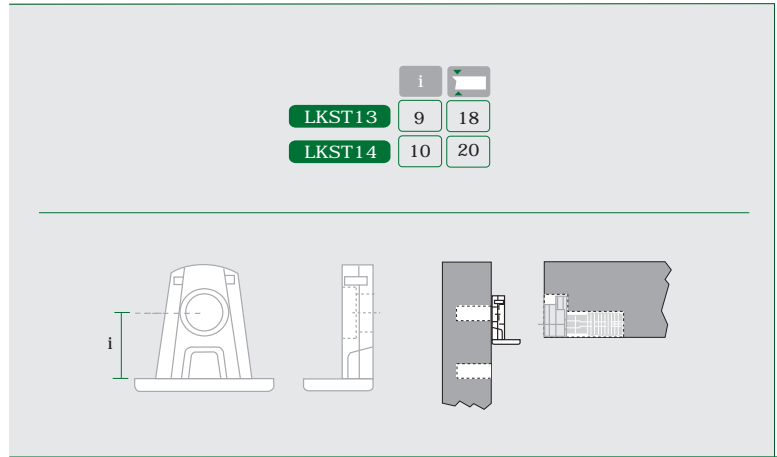

LKST

Staffa standard con bussola • Standard support w/socket



materiale • material

Zama • Zamec

finitura • finish

ZZ - ZZT - ZZN - ZBR

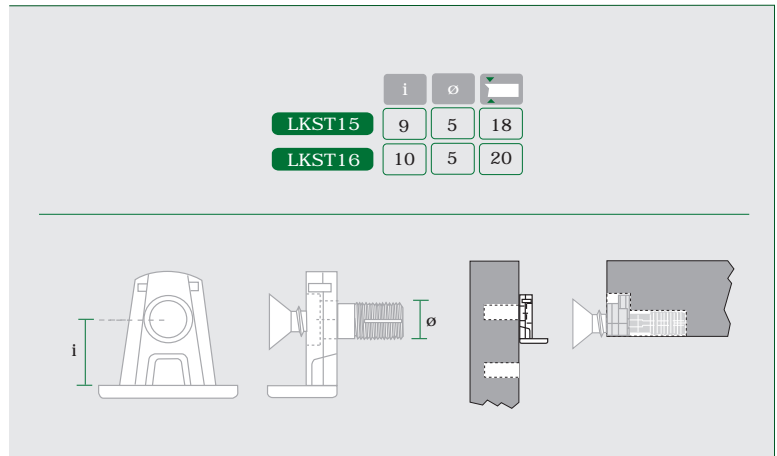

LKSI

Supporto ø25 • Support ø25



materiale • material

Plastica • Plastic

finitura • finish

PB - PNE - PMA

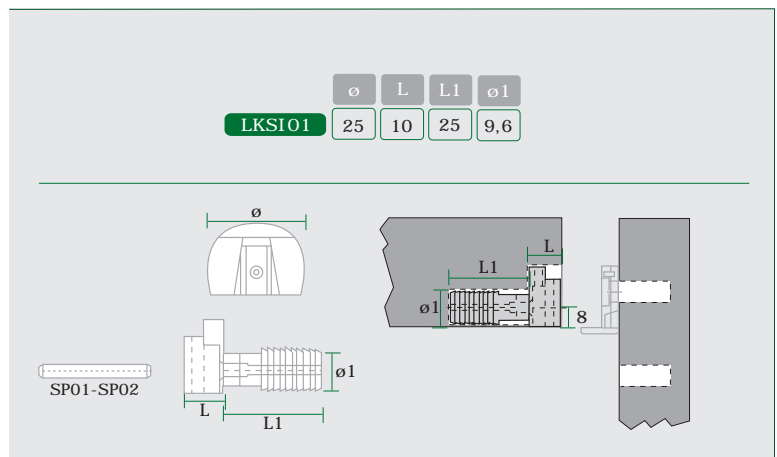





LKSI27

Supporto ø25 a pressione • Support ø25 knock-in



materiale • material

Plastica • Plastic

finitura • finish

PNE

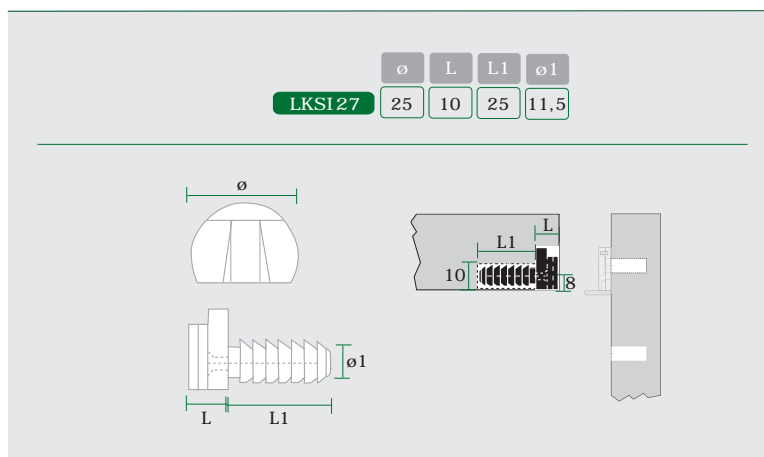

LKST

Staffa standard • Standard support



materiale • material

Zama • Zamec

finitura • finish

ZNL - ZBR - ZZN - ZZ

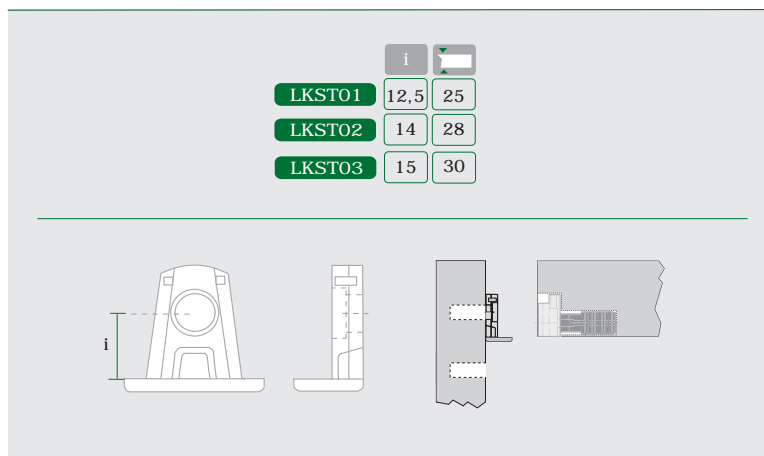

LKST

Staffa doppio fissaggio • Double fix support



materiale • material

Zama • Zamec

finitura • finish

ZNL - ZBR - ZZN - ZZ

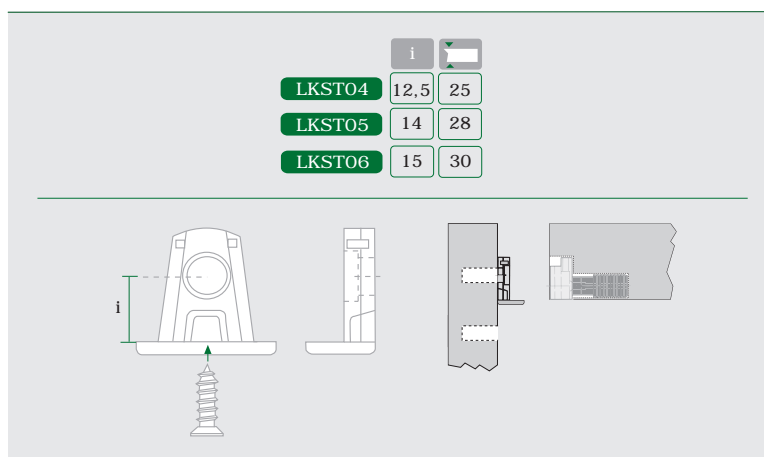

LKST

Staffa standard con bussola • Standard support w/socket



materiale • material

Zama • Zamec

finitura • finish

ZNL - ZBR - ZZN - ZZ

	i	o	
LKST07	12,5	5	25
LKST08	14	5	28
LKST09	15	5	30

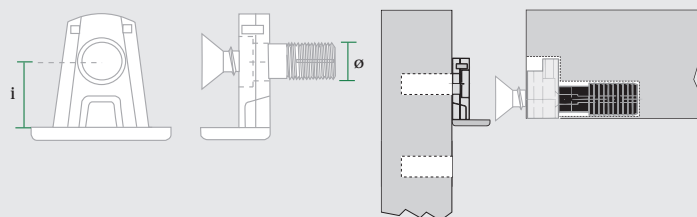

LKST

Staffa doppio fissaggio con bussola • Double fix support w/socket



materiale • material

Zama • Zamec

finitura • finish

ZNL - ZBR - ZZN - ZZ

	i	o	
LKST10	12,5	5	25
LKST11	14	5	28
LKST12	15	5	30

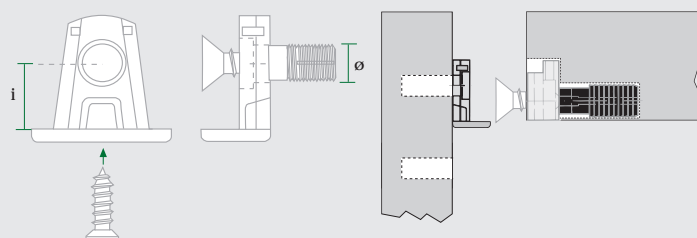

LKME03

Mensolina perno - foro • Shelf support pin + hole



materiale • material

Zama • Zamec

finitura • finish

ZZ - ZNL - ZBR - ZO - ZZN

	o	L	L1	L2	iL
LKME03	5	8	12	14	10

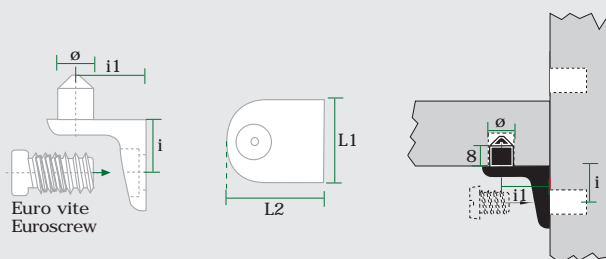



LKME30

Mensolina con vite euro premontata • W/ premounted euro-screw



materiale • material

Zama • Zamec

finitura • finish

ZZ - ZNL - ZBR - ZO - ZZN

	ø	L	L1	L2	iL	L
LKME30	5	8	12	14	10	12

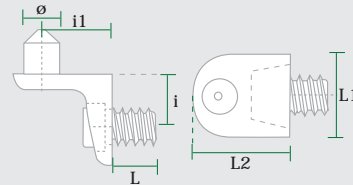

LKME18

Mensolina Major • Shelf support Major



materiale • material

Zama • Zamec

finitura • finish

ZZ - ZNL - ZBR - ZO - ZZN

	ø	i	L1	L2	i1	H
LKME18	5	8	16	16	12	10

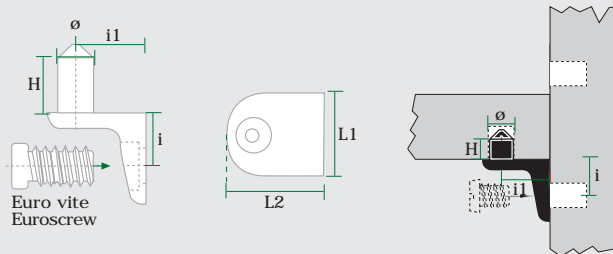

LKME02

Shelf support con vite euro premontata • Supports tablettes W/premounted euro screw



materiale • material

Ferro • Steel

finitura • finish

FZ

	L
LKME02	7,5

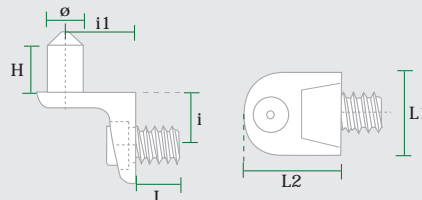

LKME04

Mensolina 2 perni • Shelf support 2 pins



materiale • material

Zama • Zamec

finitura • finish

ZZ - ZNL - ZBR - ZO - ZZN

	ø	L	L1	L2	i	ø1	i1
LKME04	5	7,5	12	14	6	5	10

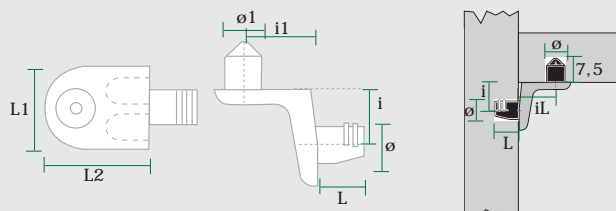

LKME05

Mensolina con perno • Shelf support w/pin



materiale • material

Zama • Zamec

finitura • finish

ZZ - ZNL - ZBR - ZO - ZZN

	ø	L	L1	L2	i
LKME05	5	7,5	12	14	6

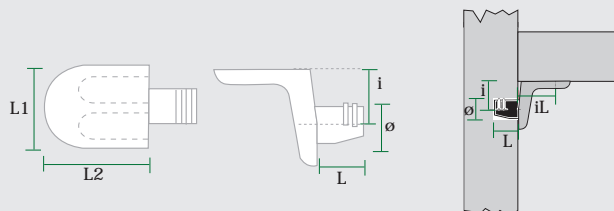

LKME35

Mensolina "slim" 2 perni • Shelf support "slim" 2 pins



materiale • material

Zama • Zamec

finitura • finish

ZZ - ZNL - ZBR - ZO - ZZN

	ø	L	L1	L2	i
LKME35	5	7,5	10,8	14	6

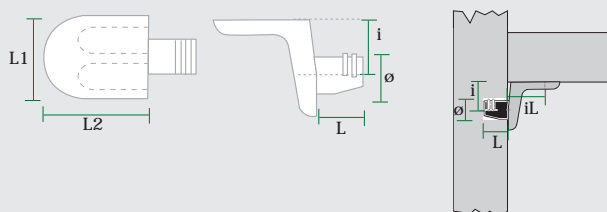



LKME20

Mensolina 2 perni con vite • Shelf suport 2 pins w/screw



	ø	i1	H1	i2	H2	L1	L2
LKME20	5	10	6,5	5,5	7,5	13	12

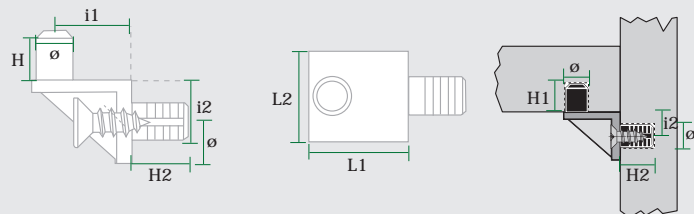

materiale • material

Plastica • Plastic

finitura • finish

PNE - PMA - PB - PGR

LKME19

Supporto mensoline click • Click support



	ø	L	L1	L2
LKME19	12	9	10,5	4,5

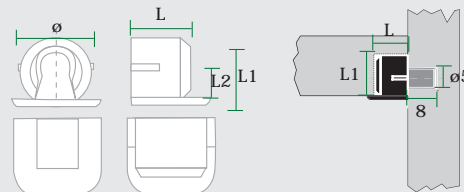

materiale • material

Plastica • Plastique

finitura • finish

PNE - PB - PMA

LKME

Mensolina in ferro • Steel shelf support



	ø	L	L1	L2	L3
LKME10	5	8	2,9	9,5	7,3
LKME11	4	8	2	8,5	6,5
LKME12	3	8	1,7	12	4,3

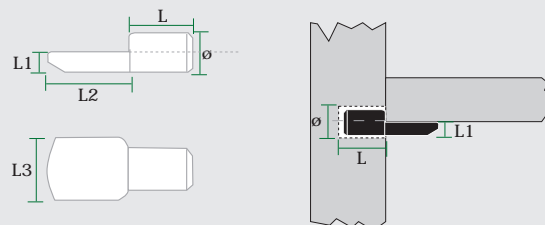

materiale • material

Ferro • Steel

finitura • finish

FZ - FZT - FNL - FBR - FZN - FO

LKME08

Mensolina con anello • Shelf support duplo



materiale • material

Ferro • Steel

finitura • finish

FZ - FNL - FZN

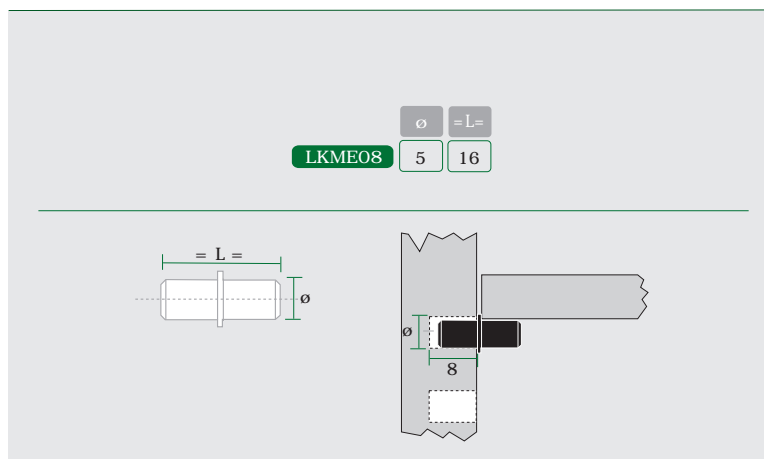

LKBR01

Bloccaripiani • Shelfstopper



materiale • material

Plastica • Plastique

finitura • finish

PN

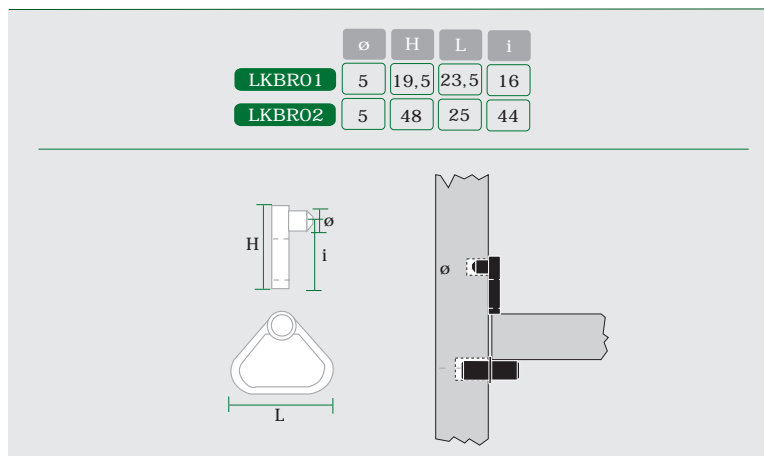

LKME09

Mensolina plastica • Plastic shelf support



materiale • material

Plastica • Plastic

finitura • finish

PB - PNE - PMA

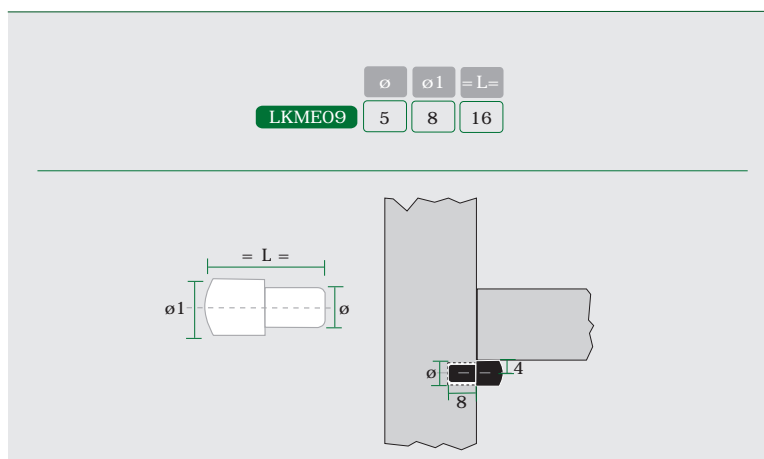



LKME15

Mensolina plastica c/perno ø5 • Plastic shelf support w/pin ø5



materiale • material

Plastica • Plastique

finitura • finish

PB - PMA

	ø	L	L1	L2
LKME15	5	7	10	10

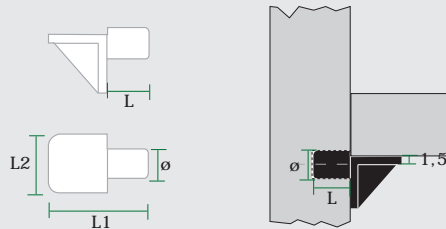

LKME16

Mensolina per fresata • Plastica shelf support for groove



materiale • material

Plastica • Plastique

finitura • finish

PB - PMA

	ø	H	L	L1	L2
LKME16	5	3	7	6	21

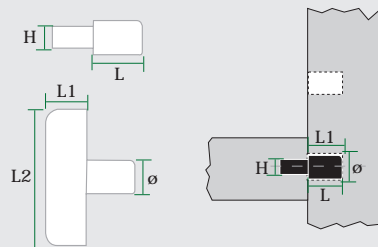

LKME

Mensolina plastica + Perno ferro • Plastic shelf support + Steel pin



materiale • material

Plastica + Ferro • Plastic + Steel

finitura • finish

PT - PB - PMA - PNE

	ø	L	L1	L2
LKME13	5	8	8	9
LKME17	3	8	8	9

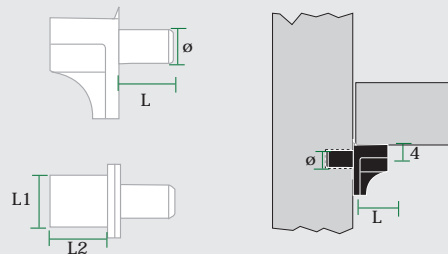

LKME21

Mensolina mini • Plastic shelf support mini + Steel pin



materiale • material

Plastica + Ferro • Plastique + Steel

finitura • finish

PT

	ø	L	L1	L2
LKME21	5	8	8	9

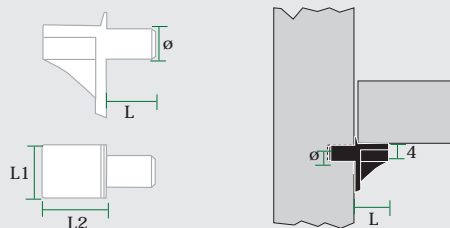

LKMV02

Supporto a ventosa • Soft rubber support



materiale • material

Gomma • Rubber

finitura • finish

PB - PT - PNE - PMA

	ø	i	L	L1
LKMV02	13	4	12	15

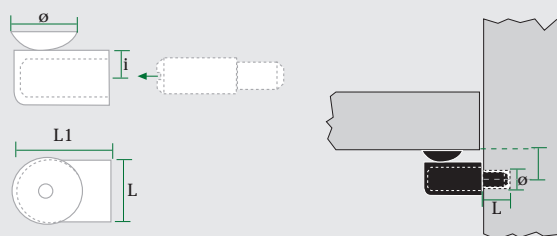

LKMV01

Mensolina piana con ventosa • Shelf supports w/sucker



materiale • material

Zama + Gomma • Zamec + Rubber

finitura • finish

ZNL - ZBR - ZO - ZZN

	ø	L	ø1	L1	L2
LKMV01	5	9	11	20	13

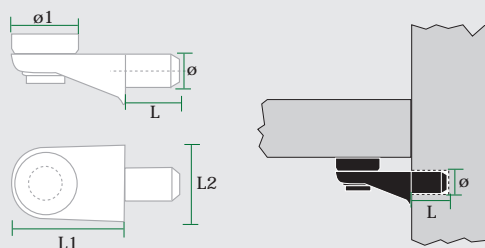





LKMV07

Mensolina con vite di bloccaggio • Shelf support w/plastic screw



materiale • material

Ferro • Steel

finitura • finish

FLN - FBR - FZN - FO

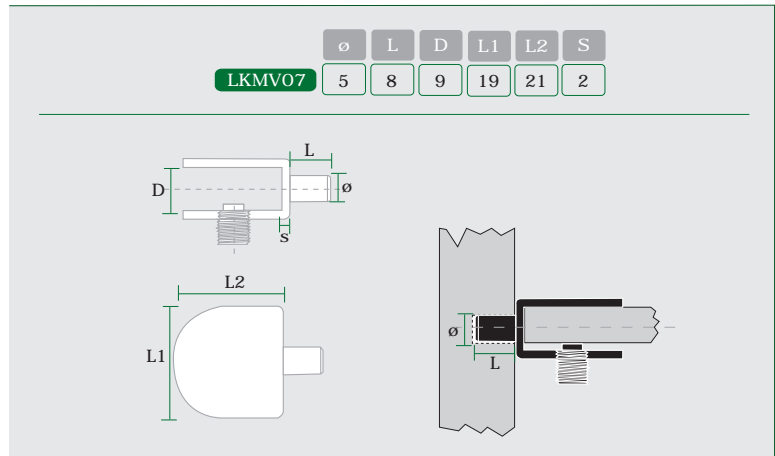

LKMV

Mensolina zama con vite di bloccaggio • Die-cast shelf support w/plastic screw



materiale • material

Zama • Zamec

finitura • finish

ZNL - ZZN - ZO - ZBR

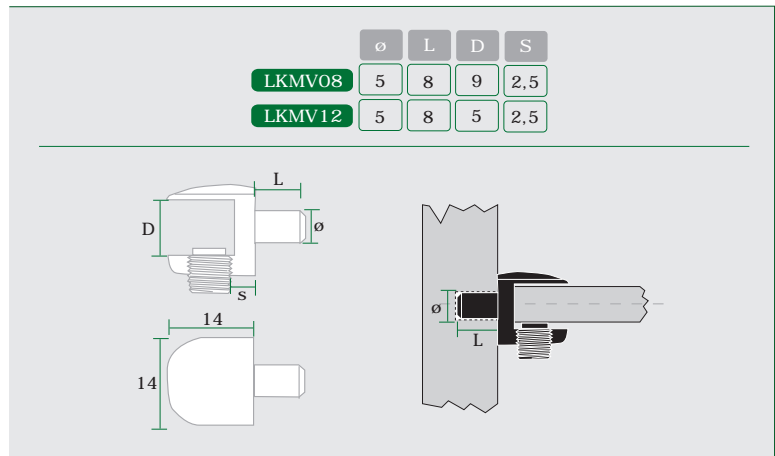

LKMV

Mensolina zama con vite di bloccaggio e foro • Die-Cast Shelf support w/plastic screw and hole



materiale • material

Zama • Zamec

finitura • finish

ZNL - ZZN - ZO - ZBR

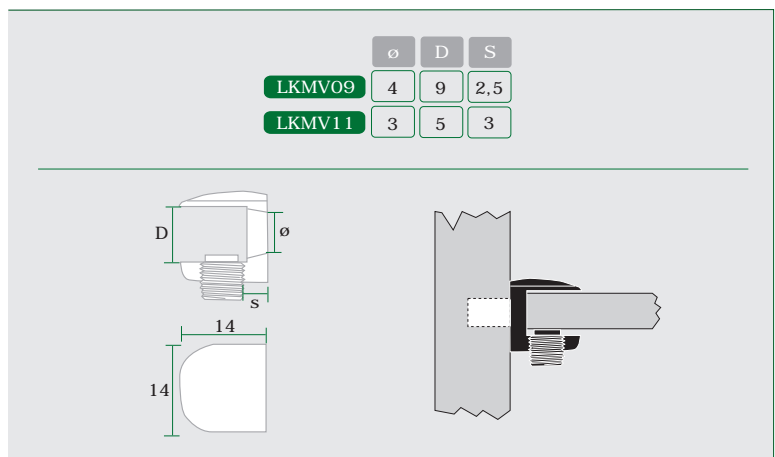

LKAL02

Mensolina 2 fori • Shelf support 2 holes



materiale • material

Zama • Zamec

finitura • finish

ZNL - ZBR - ZO - ZZN

LKAL02	L1	L2	i	i1
	18	18	12,5	12,5

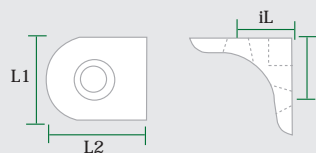

LKMV40

Mensolina zama con vite di bloccaggio • Die-cast shelf support w/plastic screw



materiale • material

Zama • Zamec

finitura • finish

ZNL + PT  
ZO + PT  
ZZN + PNE  
ZBR + PNE

LKMV40	ø	L	D	S
	5	8	9	2,5

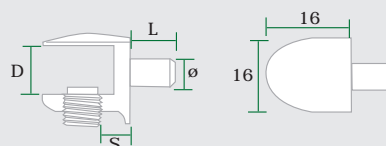

LKMV25

Mensolina zama con vite di bloccaggio e foro • Die-Cast shelf support w/plastic screw and hole



materiale • material

Zama • Zamec

finitura • finish

ZNL

LKMV25	ø	D	S
	3	6	3

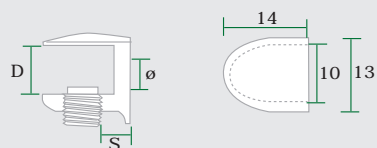

RG006

Reggipiano a paletta • Metal shelf support

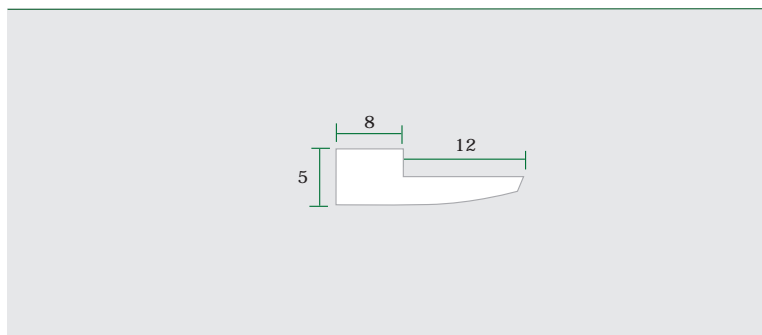

materiale • material

Metallo • Metal

finitura • finish

ZN

RG008

Reggipiano per vetro • Metal shelf support

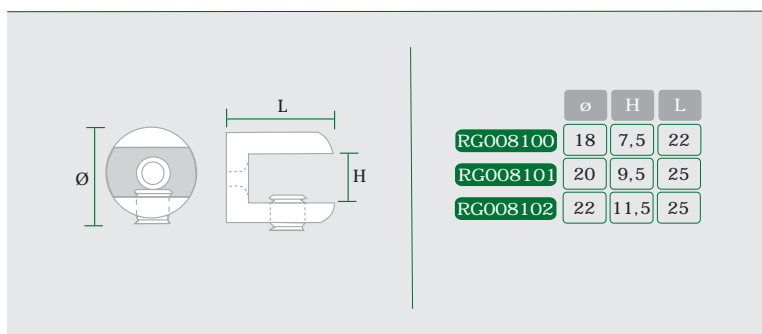

materiale • material

Ottone • Brass

finitura • finish

OT - CL

RG0011

Reggipiano a paletta • Metal shelf support

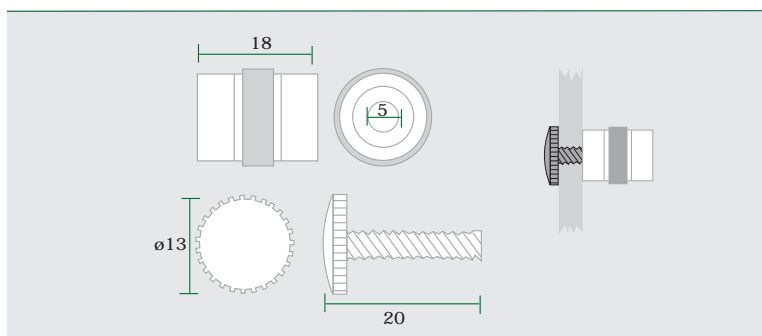

materiale • material

Ottone + Plastica • Brass + Plastic

finitura • finish

NI

RG0012

Reggipiano per vetri • Metal shelf support for glass

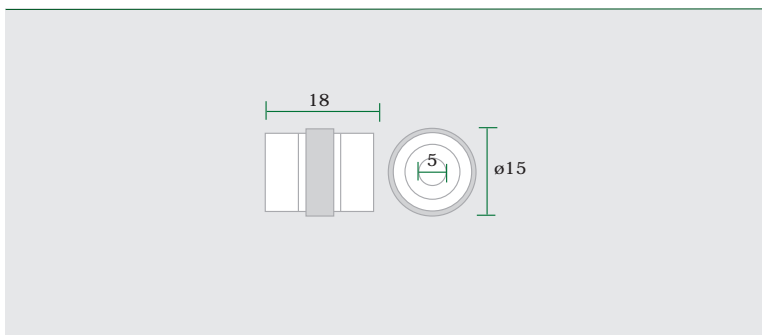

materiale • material

Ottone • Brass

finitura • finish

NI

LKMV

Mensolina ad angolo con ventosa • Angle shelf support w/sucker



materiale • material

Zama + Gomma • Zamec + Rubber

finitura • finish

ZNL - ZBR - ZO - ZZN

	ø	i	ø1	L	L1	L2
LKMV03	5	6	11	8	14	12

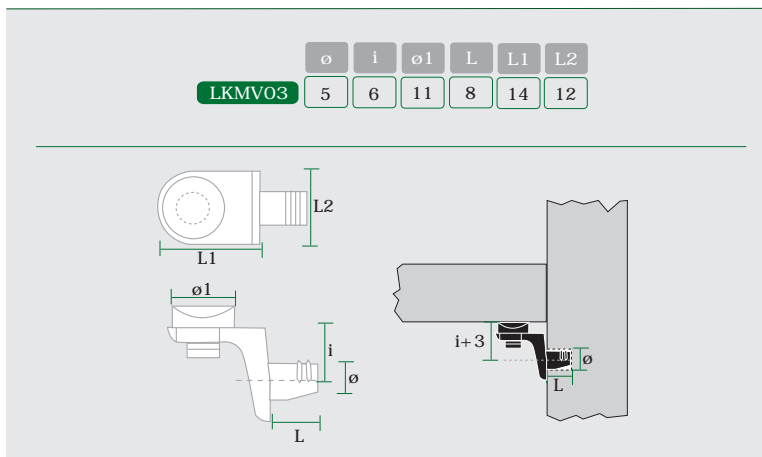

LKMV

Mensolina con o-rings • Shelf support w/o rings



materiale • material

Ferro • Steel

finitura • finish

FNL - FBR - FZN - FO

	ø	L	L1	L2
LKMV04	3	8	11	9
LKMV05	5	8	11	9

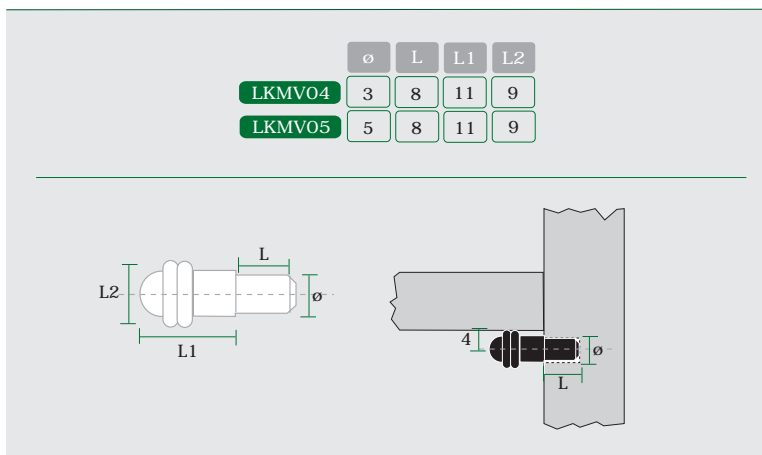

LKMV06

Mensolina economy con o-rings • Shelf support economy w/o-rings



materiale • material

Ferro • Steel

finitura • finish

FZ - FNL - FBR - FZN - FO

	ø	L	L1	L2
LKMV06	5	8	12	9

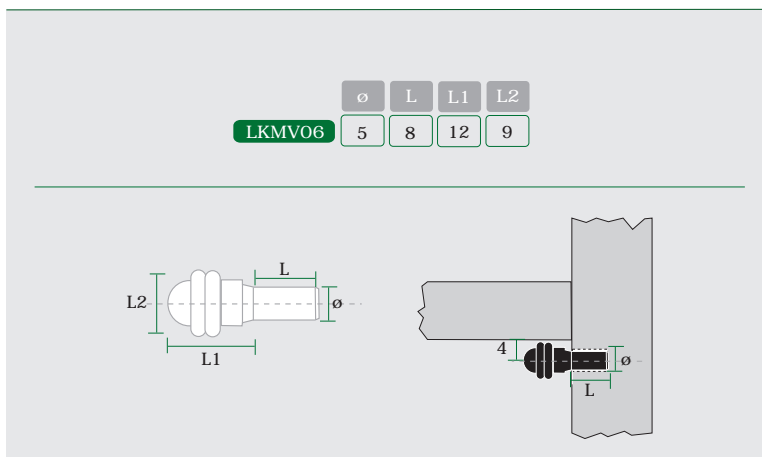



LKMV13

Mensolina M5 con O-Ring • Shelf support M5 w/O-Ring



materiale • material

Ferro • Steel

finitura • finish

FNL - FO

	ø	L	L1	M
LKMV13	7	7,5	15	M5

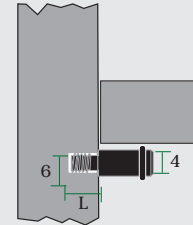
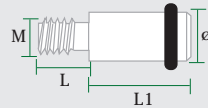

LKMV24

Mensolina Simply • Shelf support simply



materiale • material

Plastica • Plastique

finitura • finish

PT

	ø	L	S	H
LKMV24	5	7,5	2,5	8

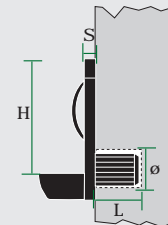
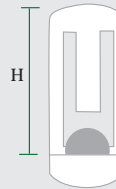

LKFM03

Fermaschiene c/vite premontata • Back connection w/premounted screw



materiale • material

Plastica • Plastic

finitura • finish

PNE - PMA - PB- PBE - PT

	H	L	P	ø
LKFM03	14	15	8,5	3,5

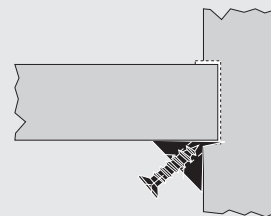
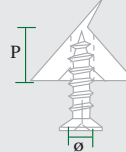
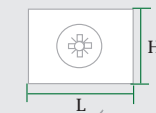

LKFM09

Fermaschiene self locking • Back connection self locking

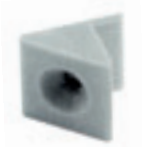

materiale • material

Plastica • Plastique

finitura • finish

PNE - PMA - PB - PBE - PT

	H	L	P	ø
LKFM09	14	15	8,5	3,5

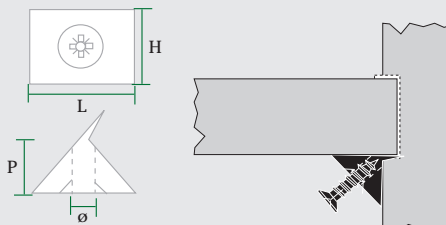

LKVG01

Vite per mobili • Furniture screw



materiale • material

Ferro • Steel

finitura • finish

FZ - FZT - FZN

	ø	L	Ø1
LKVG01	7	50	10
LKVG05	5	50	7
LKVG13	6,3	50	10

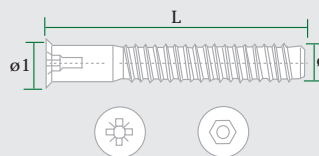

\* Altre misure su richiesta  
\* Other diameter or length on request

LKCV01

Coprivite VG01-05-13 • Cover cap for screw VG01-05-13



materiale • material

Plastica • Plastique

finitura • finish

PB - PNE - PMA

	ø	ø1
LKCV01	12	3

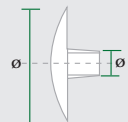

LKBA

Barilotti • Cross dowels



materiale • material

Ferro • Steel

finitura • finish

FZ - FZT - FZN

	ø	L	i
LKBA06	10	13	8
LKBA02	10	14	9
LKBA07	14	14	9

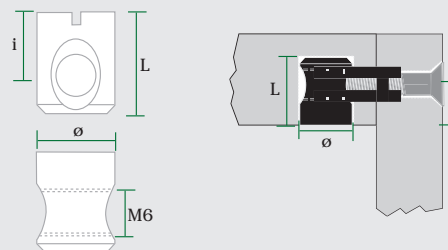

LKVF03

Vite femmina ø8 • Female screw ø8



materiale • material

Ferro • Steel

finitura • finish

FNL - FBR - FZN - FO - FZ

	ø	L	M
LKVF03	8	30	M6

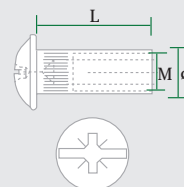

LKVC

Vite TBL M6 • Male screw M6



materiale • material

Ferro • Steel

finitura • finish

FNL - FBR - FZN - FO - FZ

	M	L
LKVC05	M6	14
LKVC11	M6	20
LKVC06	M6	25
LKVC07	M6	30
LKVC08	M6	35
LKVC09	M6	45

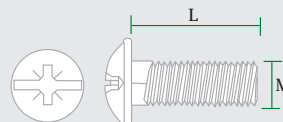

LKVF

Vite femmina ø5 • Female screw ø5



materiale • material

Ferro • Steel

finitura • finish

FLN - FBR - FZN - FO - FZ

	ø	L	M
LKVF01	5	27	M4
LKVF02	5	15	M4
LKVF04	5	30	M4

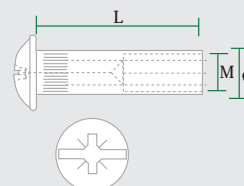

LKVC

VITE TBL M4 • Male screw M4



materiale • material

Ferro • Steel

finitura • finish

FNL - FBR - FNZ - FO - FZ

	M	L
LKVC01	M4	15
LKVC02	M4	20
LKVC03	M4	25
LKVC04	M4	30

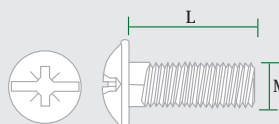

LKVF35

Vite femmina ø5 • Female screw ø5



materiale • material

Zama • Zamec

finitura • finish

FNL

	ø	L	M
LKVF35	5	13,5	M4

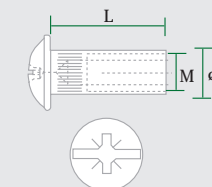





LKVC35

Vite TBL • Male screw TBL



materiale • material

Ferro • Steel

finitura • finish

FNL

	ø	L	M
LKVC35	5	27	M4

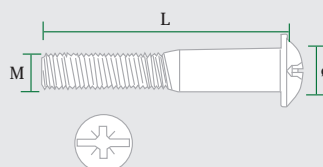

LKPRO1

Paracolpi ad assorbimento • Absorber bumper



materiale • material

Gomma • Rubber

finitura • finish

PT - PB - PMA - PNE - PN

	ø	L	ø1	H
LKPRO1	5	7,5	10	3

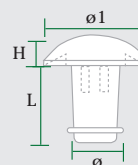

LKPRO4

Paracolpi zigrinato • Grooved bumper



materiale • material

Plastica • Plastic

finitura • finish

PT - PB - PMA - PNE - PN

	ø	L	ø1	H
LKPRO4	5	7,5	10	2,5

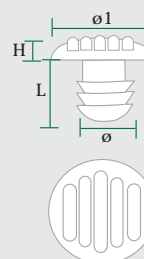

LKS0

Inserto Block  $\varnothing 18$  • Block insert  $\varnothing 18$



materiale • material

Zama + Plastica • Zamec + Plastic

finitura • finish

PB + ZL

	L		L	
LKS0010	13	16	LKS0010	18,4 26
LKS0011	14,2	18/19	LKS0011	20 26
LKS0012	17	23		

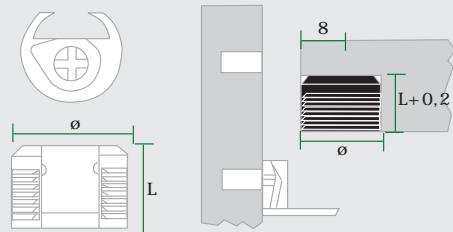

LKS0

Inserto Block  $\varnothing 20$  • Block insert  $\varnothing 20$



materiale • material

Zama + Plastica • Zamec + Plastic

finitura • finish

PB + ZL

	L	
LKS0015	14	18/19
LKS0016	17,6	26
LKS0020	20,3	28/30

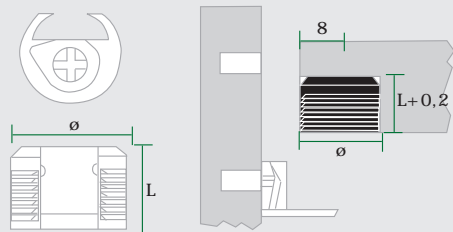

LKS0

Staffa Block • Block support



materiale • material

Zama • Zamec

finitura • finish

ZNL - ZZN - ZBR - ZO

	i		i	
LKS0030	8	16	LKS0037	13 26
LKS0032	9	18/19	LKS0038	14,5 28/30
LKS0036	11,5	23		

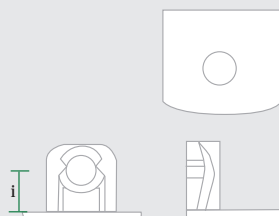



LKSO

Inserto fix ø18 • Fix insert ø18



materiale • material

Plastica • Plastic

finitura • finish

PB

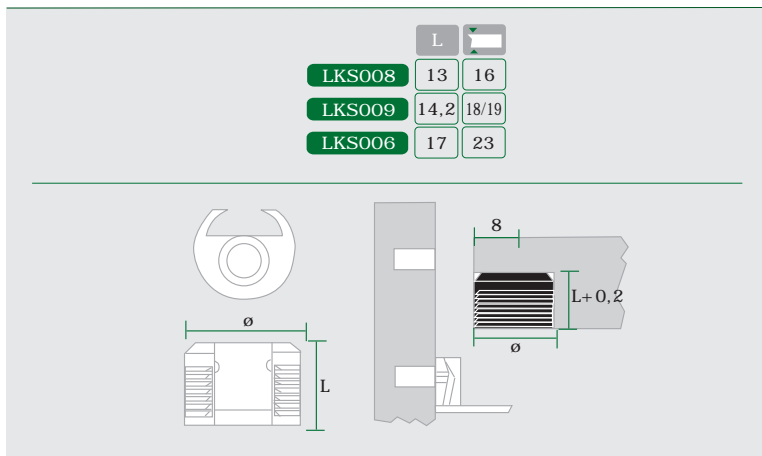

LKSO

Staffa fix • Fix support



materiale • material

Zama • Zamec

finitura • finish

ZNL - ZZN - ZBR - ZO

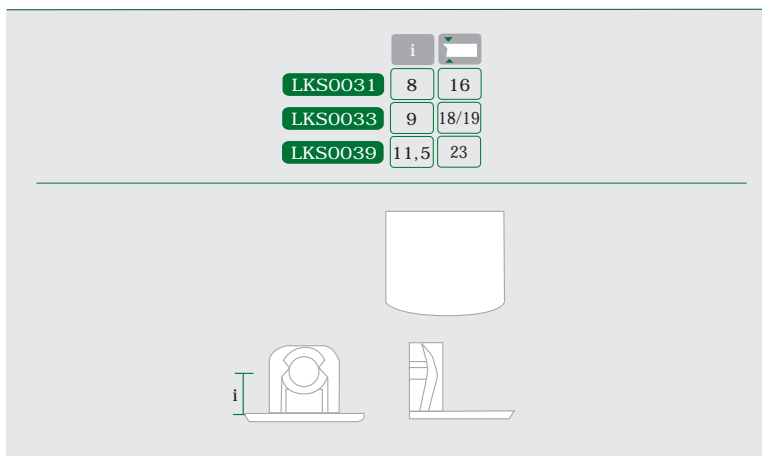

LKVE

Eurovite testa svasata piana • Euro screw flat head



materiale • material

Ferro • Steel

finitura • finish

FZ - FZN - FNL

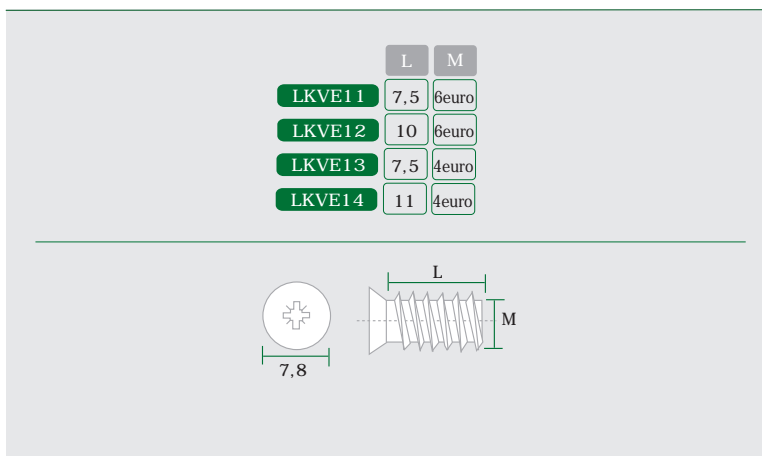

## CODICI FINITURE • FINISHES CODES

FL	Ferro Grezzo	Plain Steel
FNL	Ferro Nichelato	Nickel Plated Steel
FBR	Ferro Bronzato	Bronze Plated Steel
FO	Ferro Ottonato	Brass Plated Steel
FZ	Ferro Zincato	Zinc Plated Steel
FZN	Ferro Zincato Nero	Black Zinc Plated Steel
FZT	Ferro Tropicalizzato	Yellow Passivated Steel
FCR	Ferro Cromato	Chrome Plated Steel
FVC	Ferro Verniciato Alluminio	Aluminium Painted Steel
FNE	Ferro Verniciato Nero	Black Painted Steel
ZL	Zama Grezzo	Plain Zin Zamec
ZNL	Zama Nichelato	Nickel Plated Zamec
ZBR	Zama Bronzato	Bronze Plated Zamec
ZO	Zama Ottonato	Brass Plated Zinc Zamec
ZZ	Zama Zincato	Zinc Plated Zinc Zamec
ZZN	Zama Zincato Nero	Black Zinc Plated Zamec
ZZT	Zama Tropicalizzato	Yellow Passivated Zamec
ZCR	Zama Cromato	Chrome Plated Zamec
ZVC	Zama Verniciato Alluminio	Aluminium Painted Zamec
ZVN	Zama Verniciato Nichel	Nickel Painted Zamec
ZNE	Zama Verniciato Nero	Black Painted Zamec
ZB	Zama Verniciato Bianco	White Painted Zamec
NSAT	Zama Nichel Satinato	Galvanic Nickel Mat Zamec
OL	Ottone Grezzo	Natural Brass
ONL	Ottone Nichelato	Nichel Plated Brass
PN	Plastica Neutro	Natural Plastic
PB	Plastica Bianco	White Plastic
PNE	Plastica Nero	Black Plastic
PMA	Plastica Marrone	Brown Plastic
PT	Plastica Trasparente	Translucent Plastic
PCR	Plastica Cromato	Chrome Plated Plastic
PGR	Plastica Grigio	Grey Plastic